

minicat

ULTRA LIGHT CATAMARAN



THE WORLD'S FAVORITE PORTABLE SAILBOAT

15 years ago the idea was to create an affordable boat, flexible, lightweight, easy to transport, quick to assemble & yet giving a great sailing experience.

We designed, tested, improved and tested again and finally created an innovative product that is manufactured solely in the Czech Republic, the centre of Europe and that is now sold all over the world.

MiniCat is a high performance inflatable catamaran you can take on the plane with you when going on holidays, is easy to fit in any campervan, motorhome, RVs or even a family car and is a great addition to your super yacht without the usual storage problems.

minicat
ULTRA LIGHT CATAMARAN





EASY TO TRANSPORT

ASSEMBLED SINGLE-HANDEDLY
IN 10 - 30 MINS

NO EXTRA TOOLS REQUIRED

REMOVE MAST, ADD OUTBOARD
& CREATE AN INSTANT TENDER

SPARE PARTS & GREAT SELECTION
OF ACCESSORIES



4 SIZES / 9 MODELS

FOR 1 - 4 PEOPLE TO SAIL

ALL MODELS FIT IN 1-3 BAGS

WEIGHT FROM 28-60 KGS

24 MONTH FULL PRODUCT
WARRANTY



**MINICAT
460**

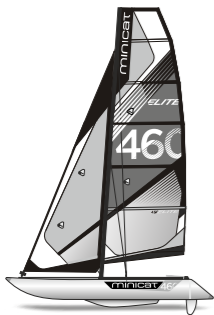

M 460 Elite
page 23.

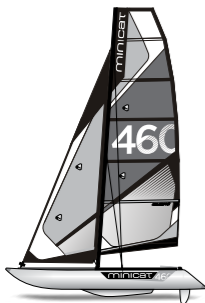

M 460 Esprit
page 21.

54 Kg
 40 min
 4600 mm
 relax sport race

**MINICAT
420**



M 420
Laura Dekker
Edition
page 19.



M 420 Emotion
page 15.

52 Kg
 30 min
 4200 mm
 relax sport race



M 420 Evoque
page 17.



M 420 Instinct
page 13.

relax sport race

**MINICAT
310
SUPER / SPORT**



page 11.

35 Kg
 25 min
 3100 min
 relax sport race

**MINICAT
GUPPY**



page 9.

29 Kg
 15 min
 3000 min
 relax sport race



MINICAT

GUPPY



MiniCat GUPPY is all about the simplicity and speed of assembly. Due to the unique design of the floats pre-attached to the frame, the set-up takes just 15 mins from start to finish. GUPPY is also exceptionally light (just 29 kg) and with grab-handles on the trampoline manipulation is easy especially for children. The funky design of the sail and no jib makes this dinghy sailboat especially appealing to first-time young sailors who want to learn sailing techniques and have fun.

OPTIONS & TECH

length	3000 mm
width	1500 mm
height of the mast	3950 mm
weight	29 kg
diameter of floats	330 mm
sail	3,9 m ²
trampoline	1600 / 1450 mm
dimensions of the bag	1650 x 300 x 300 mm
design category	'D'
carrying capacity	240 kg
number of persons	2
time of assembly / dismantling	max. 15 min.

DIMENSIONS

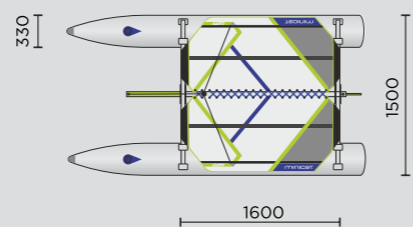
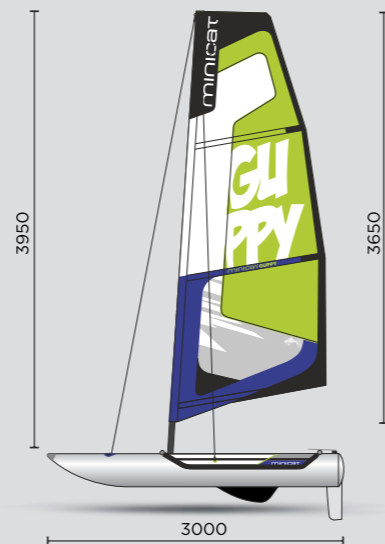

MINICAT 310 SUPER/SPORT

MiniCat 310 is designed for those lighter individual sailors who like speed and high performance or for a small family that wants compact, safe boat to have fun with.

It comes in two options: 310 Sport which includes the jib and jib-winding system - jib furler and 310 Super which is simpler and comes without the jib furler.



OPTIONS & TECH

length	3100 mm
width	1400 mm
height of the mast	3800 mm
weight	35 kg
diameter of floats	330 mm
sail	main sail+jib
main sail	3.75 m ²
jib	1,4 m ²
trampoline	1350x950 mm
dimensions of the bag	1350x300x400 mm
design category	'D'
carrying capacity	240 kg
number of persons	2
time of assembly / dismantling	25 min.

DIMENSIONS

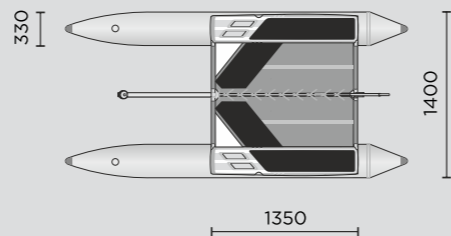

MINICAT 420 INSTINCT

The 420 Instinct is the perfect family boat that excels with its exceptional stability and simplicity. The practical batten-wired Dacron sail is designed without a boom, which provides greater comfort and safety of all crew members, especially children.



OPTIONS & TECH

length	4200 mm
width	2100 mm
height of the mast	5050 mm
weight	51 kg
diameter of floats	450 mm
sail	main sail+jib
main sail	6.5 m ²
jib	3.2 m ²
trampoline	1900x1350 mm
dimensions of the bag	2x 1750x300x300 mm
design category	'D'
carrying capacity	450 kg
number of persons	4
time of assembly / dismantling	30 min.

DIMENSIONS

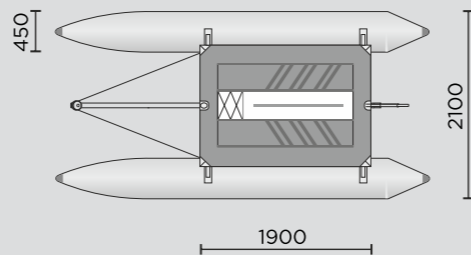
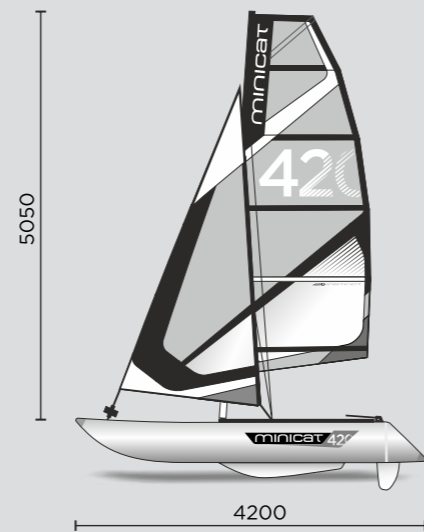

MINICAT 420 EMOTION

The perfect sports boat, built for the pleasure of sailing fast. The 420 Emotion offers a true sporting experience, but also surprises with its' versatility. The main sail from of transparent monofilm is controlled by an aluminum boom. This enables the optimal sail profile settings to achieve maximum performance and speed.

This model can be completed with a Gennaker sail and Snuffer.



OPTIONS & TECH

length	4200 mm
width	2100 mm
height of the mast	5050 mm
weight	53 kg
diameter of floats	450 mm
sail	main sail+jib
main sail	6.5 m ²
jib	3.2 m ²
trampoline	1900x1350 mm
dimensions of the bag	2x 1750x300x300 mm
design category	'D'
carrying capacity	450 kg
number of persons	4
time of assembly / dismantling	30 min.

DIMENSIONS

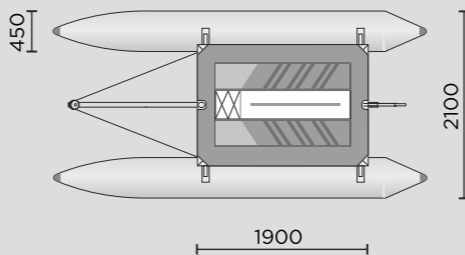
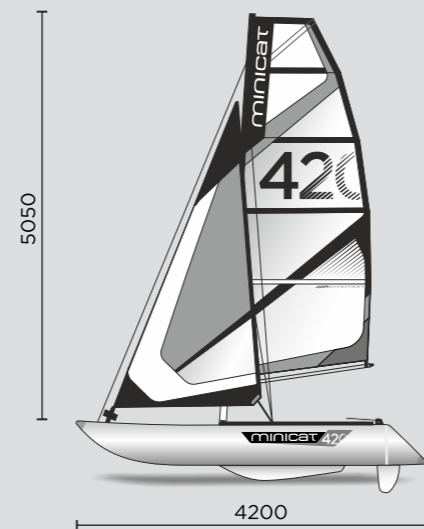

MINICAT 420 EVOQUE

An exciting, sporty, adrenalin-filled ride!
 The 420 Evoque is created in a unique style from hi-tech materials. With the prominent parts from carbon fibre with black frame and sails, this boat performs as it looks. Fast, sleek, stylish & cool.
 This model can be completed with a Gennaker sail and Snuffer.



OPTIONS & TECH

length	4200 mm
width	2100 mm
height of the mast	5050 mm
weight	52 kg
diameter of floats	450 mm
sail	main sail+jib
main sail	6.5 m ²
jib	3.2 m ²
trampoline	1900x1350 mm
dimensions of the bag	2x 1750x300x300 mm
design category	'D'
carrying capacity	450 kg
number of persons	4
time of assembly / dismantling	30 min.

DIMENSIONS

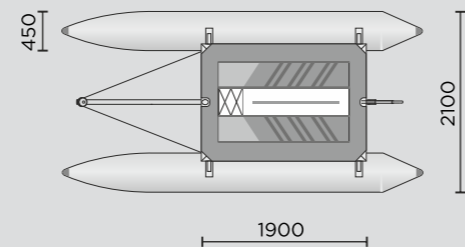
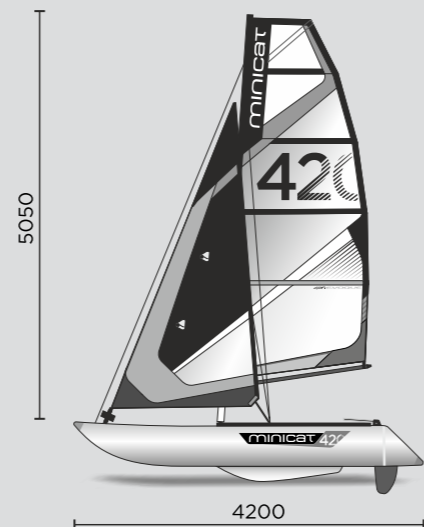

MINICAT 420 Laura Dekker Edition

An exciting high-tech Limited Edition MiniCat designed in cooperation with Laura Dekker – the youngest sailor to single-handedly circumnavigate the world.

The design is based on MiniCat 420 Evoque using carbon fiber fittings, matt finish of the frame, two-coloured mast, fantastic eye-catching design of sail & jib and and trampoline with embroidered logo of Laura Dekker.

The MiniCat 420 Laura Dekker appeals to sailors who like individuality, for those who seek a great, high-performance boat with a colourful, funky sail design. This model can be completed with a Gennaker sail and Snuffer.

by *Laura Dekker*

OPTIONS & TECH

length	4200 mm
width	2100 mm
height of the mast	5050 mm
weight	52 kg
diameter of floats	450 mm
sail	main sail+jib
main sail	6.5 m ²
jib	3.2 m ²
trampoline	1900x1350 mm
dimensions of the bag	2x 1750x300x300 mm
design category	'D'
carrying capacity	450 kg
number of persons	4
time of assembly / dismantling	30 min.

DIMENSIONS

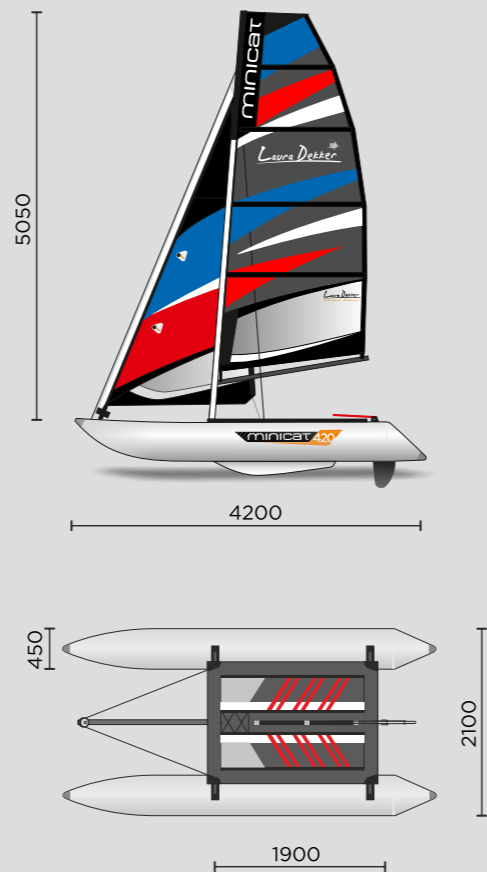

MINICAT 460 ESPRIT

The largest and most powerful MiniCat. The potential of the 460 Esprit is for those who seek maximum performance, speed and exhilaration. This boat constantly surprises with the simplicity of its handling. Constructed of the latest materials and technology, the 460 Esprit is ultra-light weight and delivers an exceptional sailing experience. This model can be completed with a Gennaker sail and Snuffer.



OPTIONS & TECH

length	4600 mm
width	2200 mm
height of the mast	6100 mm
weight	58 kg
diameter of floats	490 mm
sail	main sail+jib
main sail	8.0 m ²
jib	3.5 m ²
trampoline	1900x1450 mm
dimensions of the bag	2x 1750x300x300 mm + 1000x300x300 mm
design category	'D'
carrying capacity	450 kg
number of persons	4
time of assembly / dismantling	40 min.
optional Gennaker	12.0 m ²

DIMENSIONS

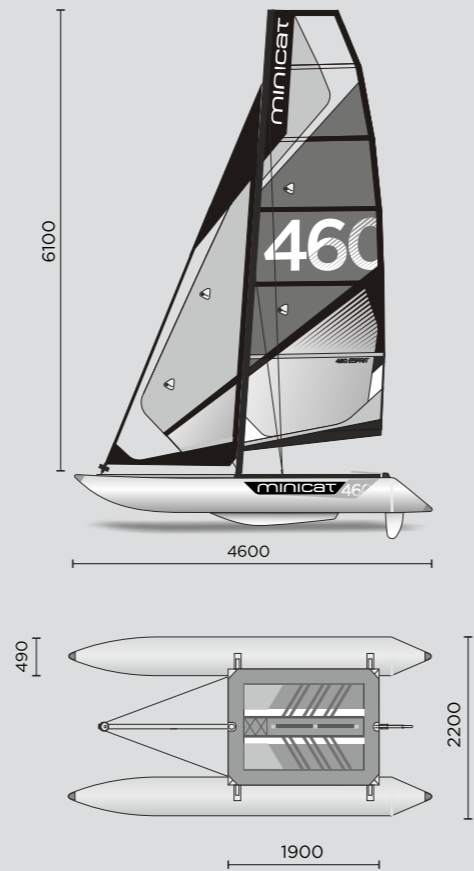

MINICAT 460 ELITE

The all-new 'MiniCat 460 Elite' is a high-tech edition to the largest category of the MiniCat portable sailboat range and its name really says it all. The construction is based on the MiniCat 460 Esprit, designed for experienced sailors but the latest model 'Elite' takes the MiniCat 460 range to a new level of style, class and performance through the use of an ultra-light carbon fiber mast, rudder and bowsprit together with some eye-catching details of embroidery on the trampoline. 460 Elite is a serious boat for serious sailors!

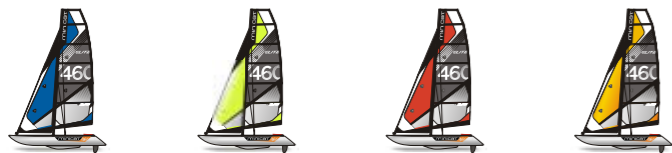

OPTIONS & TECH

length	4600 mm
width	2200 mm
height of the mast	6100 mm
weight	54 kg
diameter of floats	490 mm
sail	main sail+jib
main sail	8.0 m ²
jib	3.5 m ²
trampoline	1900x1450 mm
dimensions of the bag	2x 1750x300x300 mm + 1000x300x300 mm
design category	'D'
carrying capacity	450 kg
number of persons	4
time of assembly / dismantling	40 min.
optional Gennaker	12.0 m ²

DIMENSIONS

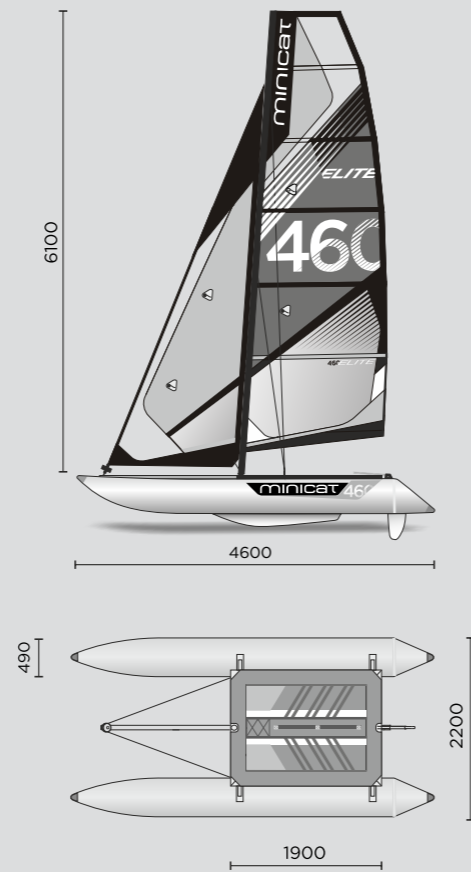

CARBON COMPONENTS

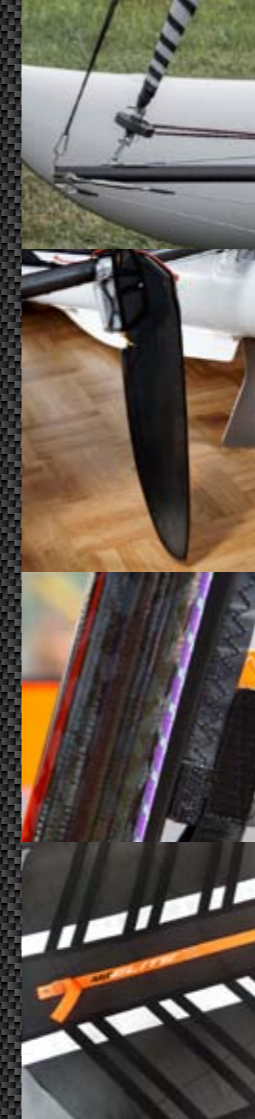

1.



2.



3.



4.



5.



6.



7.



8.



9.



11.



- 1. Compressor powered by car battery
- 2. Telephone case
- 3. Waterproof sacks 5l / 12l / 20l / 40l
- 4. Telescopic paddle
- 5. Inflation pump 6 liter with regulation



minicat **GUPPY**

minicat **310**

minicat **420**

minicat **460**

- 6. Trapeze kit
- 7. Windmeter
- 8. Pressure gauge
- 9. Wind flag
- 10. Engine support
- 11. Mast float



ACCESSORIES & SPARE PARTS



12.



15.



16.



17.



13.



14.



18.

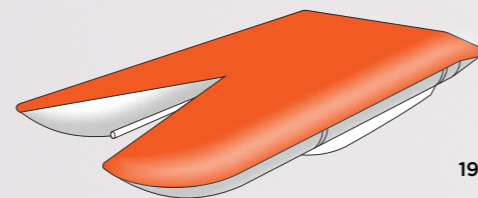

19.

- 12. Carbon mast
- 13. Two smaller bags for M310
- 14. Wheelie bag
- 15. Transport trolley
- 16. Float support
- 17. Inflatable seats
- 18. Additional trampoline
- 19. Protective cover



minicat GUPPY	minicat 310	minicat 420	minicat 460
----------------------	--------------------	--------------------	--------------------



GENNAKER & SNUFFER



The Gennaker is an additional, large, ultra-light, balloon-like, triangular sail which significantly improves the performance when sailing with low, back and side winds. It stores into a sleeve/pocket Snuffer for easy, safe handling and storage.

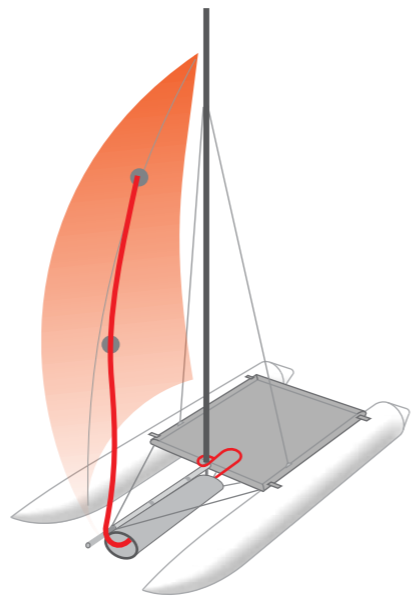

Gennaker and Snuffer are available as accessories for 420 Emotion, Evoque and Laura Dekker Ltd. and for 460 Esprit and 460 Elite.





A GREAT TENDER FOR CRUISING YACHTS & FANTASTIC ADDITION FOR YOUR CAMPING AND SAILING HOLIDAYS.



VERSATILITY OF MINICAT

MINICAT AMBASSADORS



WILLIAM THOMSON

MiniCat Brand Ambassador

www.tidalcompass.com

William is a 'Fellow of the Royal Geographic Society' an adventurer, renowned author, artist, public speaker, lecturer, passionate environmentalist and of course MiniCat sailor. Through his 'Tidal Compass' organisation William is building a boat to sail a 5 year voyage to study the effect of climate change on the world's oceans. In cooperation with marine experts, international universities and with agreed coverage from major world media and syndicated TV coverage, the entire adventure from build to voyage is destined to become a major human interest story.

We are proud to actively support William and Tidal Compass and a MiniCat 420 will be along for the voyage to work as a tender and to provide sailing fun along the way. Tidal Compass has already been featured in UK's Daily Telegraph, Daily Mail, Guardian, The Times, BBC and Conde Naste Traveller.

LAURA DEKKER

MiniCat Brand Ambassador

www.lauradekkerworldsailingfoundation.com

Laura needs no introduction, the youngest person ever to sail solo around the world. After a highly publicised court battle in the Netherlands closely followed by the world's media, Laura completed her solo circumnavigation aged just 16. Having first sailed a MiniCat whilst on her voyage Laura has become a MiniCat fan, a MiniCat owner, a MiniCat ambassador and a close friend.

We are proud to actively support 'The Laura Dekker World Sailing Foundation' and to work with Laura to make this great project a reality. Laura is building a new boat to take young people on ocean voyages to challenge them, teach them life-skills as well as sailing skills and open their eyes to the world (beyond digital).





MINICAT MODEL OVERVIEW

	GUPPY	SUPER	SPORT	INSTINCT	EMOTION	EVOQUE	LAURA DEKKER	ESPRIT	ELITE
MODELS			310				420		460
Number of persons	2	2	2	4	4	4	4	4	4
Lenght (cm)	300	310	310	420	420	420	420	460	460
Weight (kg)	29	35	35	51	53	52	52	58	54
Bags	1	1	1	2	2	2	2	3	3
Time of assembly (min.)	15	25	25	30	30	30	30	40	40
Main sail (m ²)	3,9	3,75	3,75	6,5	6,5	6,5	6,5	8,0	8,0
Jib	-	1,4	1,4	3,2	3,2	3,2	3,2	3,5	3,5
Sail material	Dacron	Dacron	Dacron	Dacron	Monofilm	Monofilm X-Ply	X-Ply Carbon	X-Ply Carbon	X-Ply Carbon
Gennaker (opt.)	-	-	-	-	yes	yes	yes	yes	yes
Boom	-	-	-	-	alu	carbon	carbon	-	-
Jib Furler	-	-	yes	yes	yes	yes	yes	yes	yes
Engine support	yes	yes	yes	yes	yes	yes	yes	yes	yes



MATERIALS & DESIGN

MAST

Made of aluminum alloy with teardrop profile. Composed of 3 parts (310 + 420) or of 4 parts (460).



SAILS

Sail materials are made from: Dimension Polyant - Dacron, Monofilm, Racing polyester X-PLY line.

FRAME

Frames are foldable and made from profiles of strengthened aluminum alloys that guarantees very low weight.

RUDDER

Depending on the model the rudder is made from fiberglass or carbon fibre produced by epoxy technology RTM.

KEEL FINS

Both floats are fitted with keel fins in order to keep the direction and avoid the leeway.

All MiniCats are hand-produced in the EU with only European materials and according to EU standards and norms.



WORLDWIDE DISTRIBUTOR:

MORAVIAN EXPORTS, s.r.o.

trading as:

MINICAT WORLDWIDE

Czech Republic

tel: +420 776 749 175

info@minicatamaran.eu

www.minicatamaran.eu

Company registered
in Czech Republic

 @minicatamaran

 /minicat

 @minicatsailing

 search: MiniCat

**YOUR LOCAL
DISTRIBUTOR:**



© All Rights Reserved
Moravian Exports, s.r.o.

minicat
ULTRA LIGHT CATAMARAN